

HYDRATION PRODUCTS

DRINKING
FOUNTAINS

BOTTLE
FILLERS



This brochure represents a portion of the extensive hydration product line that HAWS® offers.

Visit www.hawsco.com for a comprehensive list of products and accessories.

model 1211SFH



ABOUT HAWS®

Global Customers
Global Vision
Local Service

Ingenuity is the *Haws* culture. Every day we work to address your needs and solve your challenges by applying imagination and initiative to make your job easier. *Haws* is committed to improving the health and safety of our global community by providing customer focused hydration, safety, and tempering solutions. With more than 8,000 distribution locations and 250 employees worldwide, we continually focus on quality, service, reliability and complete solution support.

With the invention of the drinking fountain in 1906 by Luther Haws, the *Haws* Sanitary Drinking Faucet Company formed in 1909 in Berkeley, California. During the 1950s, *Haws* introduced emergency drench showers and safety eyewashes into its manufacturing line. Establishing headquarters in Sparks, Nevada in 1996, *Haws* continued expanding, opening various global locations. In 2018, the Nevada Division of Industrial Relations awarded SHARP status (Safety and Health Achievement Recognition Program) to *Haws*.

CORE PURPOSE: To Improve the Health & Safety of Our Global Community



HYDRATION STATION™ Electric Water Coolers & Bottle Fillers

DURABLE

- Vandal resistance features include a hidden programming button, anti-rotational bubbler head, torx bit access screws, steel frame, and fasteners hidden from view
- Integral laminar flow technology
- Enhanced tankless water cooler for consistently cooled water during use (Patent # US11203516B2)
- Self-leveling mounting system ensures flush alignment every time (Patent # US10934694B1)

HYGIENIC

- 24-hour purge feature on bottle filler
- NSF certified carbon block filter cartridge
- Service life: 1 year or 3,000 gallons (11356L)
- Hands-free sensor options available
- Sensor-activated bottle filler



SUSTAINABLE

- Energy saving 24-hour automatic shut-off feature when idle for extended periods of time
- Bottle counter display for single use plastic bottles saved
- 100% lead-free waterways

FUNCTIONAL

- Industry-leading bottle fill rate (1.5 gpm)
- Large clearances make filter replacement and maintenance painless
- Designed with retrofit and replacement advantages

QUALITY THAT DELIVERS. DESIGN THAT CAPTIVATES.

Essential to any project.

Designed with the installer in mind, the unit provides large clearances inside to allow for easy installation, filter replacement, and maintenance. All of these features make the EWC the most economical and modern choice on the market.



1212SF **HI-LO, FILTERED ELECTRIC** **WATER COOLER WITH BOTTLE** **FILLER**

Hi-lo, stainless steel, filtered electric water cooler with sensor-operated bottle filler.



1211SF **SINGLE, FILTERED ELECTRIC** **WATER COOLER WITH BOTTLE** **FILLER**

Single, stainless steel, filtered electric water cooler with sensor-operated bottle filler.



1210SF **FILTERED ELECTRIC WATER** **COOLER BOTTLE FILLER**

Stainless steel, filtered, sensor-operated electric water cooler bottle filler with resting platform from basin.

1202SF **HI-LO, FILTERED ELECTRIC WATER** **COOLER**

Hi-lo, stainless steel, filtered electric water cooler with an electronic valve and push bar assembly.

1201SF **SINGLE FILTERED ELECTRIC WATER** **COOLER**

Single, stainless steel, filtered electric water cooler with an electronic valve and push bar assembly.



All models available with non-filter options.

OUTDOOR BOTTLE FILLER & DRINKING FOUNTAIN

This highly-configurable product comes with fully ADA compliant standard models ideal for all outdoor installations, including school campuses, office courtyards, parks and recreational facilities.



3611 with 3670 dog bowl
ADA OUTDOOR STAINLESS STEEL BOTTLE FILLER AND FOUNTAIN WITH DOG BOWL
 Heavy-duty outdoor, ADA pedestal bottle filler, drinking fountain and dog bowl with matte silver powder-coated finish. **AVAILABLE IN CUSTOM COLORS**



CUSTOM COLOR OPTIONS



model 3612F

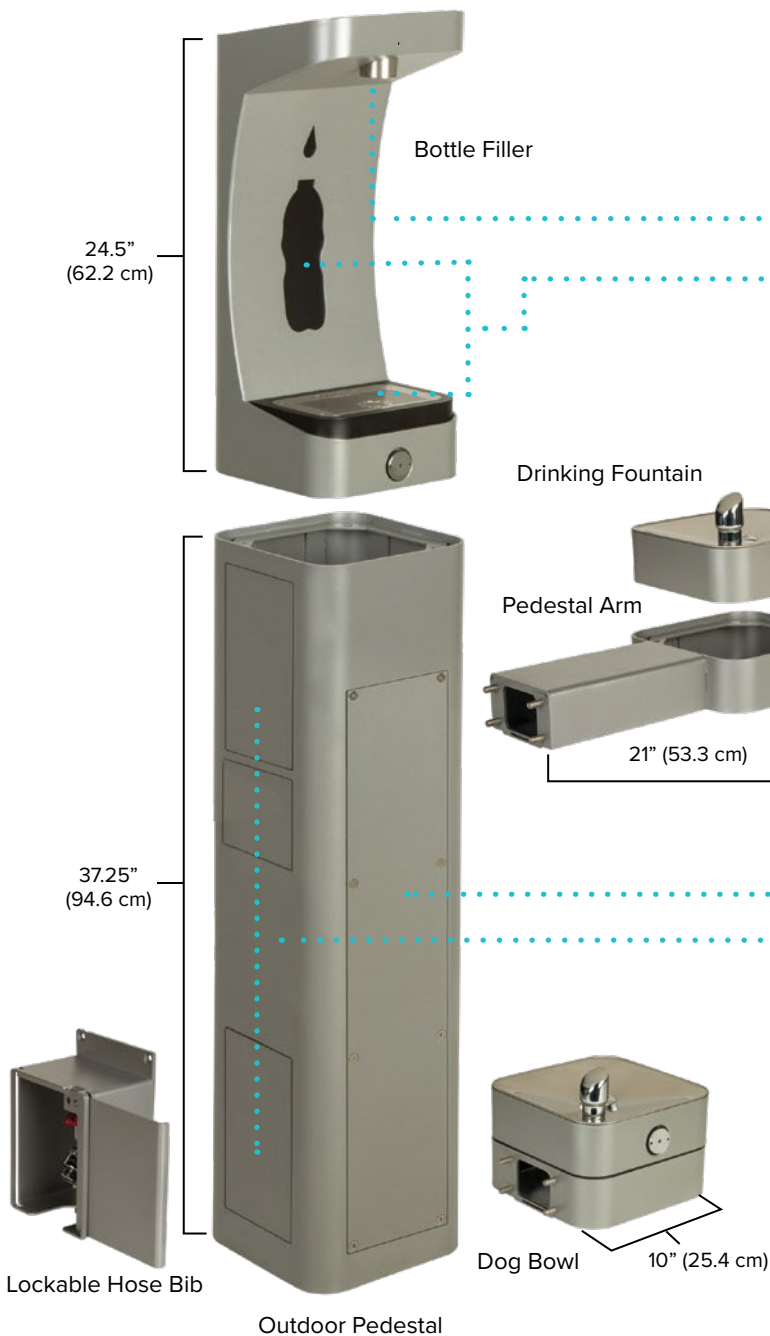

KEY FEATURES:

- All stainless steel valve body for durability, and fully serviceable through the front of the push button assembly to access water control cartridge and water stream height adjustment
- Certified by CSA to NSF/ANSI 61, Section 9 and NSF/ANSI 372
- Standard models are fully ADA compliant
- Laminar, 1 GPM (3.8LPM) flow rate
- Drain pan logo and bottle color customization available
- Interchangeable accessory options
- 100% lead free waterways
- Modular arm design for pre- and in-field placement and variations
- Base pedestal is equipped with five hydration placement options and three lower accessory options
- Industry's smallest installation footprint
- Easy installation with convenient access to internal plumbing
- Top-down drain access for easy cleaning and maintenance
- Stainless steel with silver matte powder-coated exterior for an aesthetically appealing look that will withstand the elements
- Freeze-resistant (FR) options to maintain functionality in cold weather environments
- Filter (F) options with 3000 gallon carbon block filter that reduces chlorine (taste and odor) and lead, and removes 99.99% of cysts
- Competitive pricing with multiple configuration options
- Environmentally-friendly hydration solution for reduced plastic consumption

*will increase lead times

STANDARD COLOR



For custom colors, contact customer service:
customerservice@hawesco.com, or call 888.640.4297.

WALL MOUNTED ARCHITECTURAL



1001HPS **BARRIER-FREE FOUNTAIN**

Barrier-free, high-polished stainless steel drinking fountain with sculpted bowl and 100% lead-free waterways.



1011HPSHO **BARRIER-FREE, HI-LO FOUNTAIN**

With one sensor-operated button and one push button allowing for a touchless option. High-polished stainless steel fountain with round sculpted bowls. Model 1011HPSHO2 provides two sensor-operated buttons.



FEATURES & BENEFITS

- Touchless activation options
- 100% lead-free waterways
- 18-gauge, Type 304 stainless steel bowl with 14-gauge bracket
- Polished, chrome-plated brass vandal-resistant bubbler and push button
- Satin stainless steel, and high-polished stainless steel finishes available
- Custom finishes and configurations available
- Laminar flow which produces a more even flow and eliminates splashing
- Barrier-free for ADA access
- Front access stream adjustment, cartridge and strainer
- Elegant swirl bowl design channels water to ensure proper drainage
- Vandal-resistant components and bottom plates
- 100% U.S.A. factory pressure tested to meet the highest quality standards



1001HPSHO
SENSOR-OPERATED, BARRIER-FREE FOUNTAIN

Sensor-operated, high-polished stainless steel drinking fountain with round sculpted bowl and 100% lead-free waterways.



1001MS
BARRIER-FREE, IN-WALL MOUNTED FOUNTAIN

Barrier-free, satin finish, stainless steel drinking fountain with sculpted bowl, back panel and in-the-wall mounting system, and 100% lead-free waterways. Sensor-operated model available, 1001MSHO.

H1011.8HO2
SENSOR-OPERATED, HI-LO FOUNTAIN

Sensor-operated hi-lo fountain for touchless hydration. Stainless steel with satin finish, unit provides 8 GPH (30.28 LPH) of chilled water. Model H1011.8HO also available with one sensor-operated button and one push button.

H1001.8HPSHO
SENSOR-OPERATED FOUNTAIN

Sensor-operated fountain for touchless hydration. High-polished stainless steel model provides 8 GPH (30.28 LPH) chilled water. Push button model available, H1001.8HPS.



WALL MOUNTED

FEATURES & BENEFITS - 2000S & 2000SMS

TOUCHLESS BOTTLE FILLING STATIONS

2000S

- Recessed into wall (shown)
- Plumbed drain
- Automatic 24-hour purge feature
- ADA accessible*
- 15" W x 3.9" D x 30.25" H

2000SMS

- Surface mounted on wall
- Integral drain pan with plumbed drain option
- Automatic 24-hour purge feature
- ADA accessible*
- 15" W x 6.9" D x 30.25" H

*when mounted at correct height



Customize your new or existing drinking fountain or bottle filler with your logo, slogan, or graphic! Increase brand recognition by personalizing your hydration products by easily retrofitting with a custom back panel, model 6475.

H1117LN.8-1920

HI-LO DUAL FOUNTAIN AND BOTTLE FILLER

Barrier-free, 14-gauge, hi-lo electric water cooler and bottle filler with adult and child ADA capabilities. Sensor-operated model H1117LN.8HO2-1920HO available.



FEATURES & BENEFITS

- 100% lead-free waterways
- Polished, chrome-plated brass bubbler, push button and waster strainer
- Barrier-Free
- Front access stream adjustment, cartridge and strainer
- Vandal-resistant components
- Integral waste trap
- 100% U.S.A. factory pressure tested to meet the highest quality standards



1920 and 1920HO
BOTTLE FILLING STATION

Push button and sensor-operated models available for the versatile, wall-mounted, satin finished bottle filler that can be mounted alone or above a drinking fountain. Constructed of 14-gauge, Type 304 satin finish stainless steel with 100% lead-free waterways and 1 GPM (3.78 LPM) laminar flow.



Model 1001HO-1920HO shown with back plate models BP6 and BP15

1922
BOTTLE FILLER W/DRIP TRAY DRAIN

This wall mounted bottle filler offers the 'only' all stainless-steel valve body that is machined out of solid bar stock, is fully serviceable through the front of the push button assembly offering access to the water control cartridge and integral water supply strainer, and has front access to the water stream height adjustment for easy maintenance without having to remove the valve. Sensor-operated model 1922HO available.



Model H1119.8HO-1920HO shown with back plate model BP32 and drip tray model 6469

H1119.8HO-1920HO
HI-LO ELECTRIC WATER COOLER

Sensor and push button operated, hi-lo electric water cooler provides 8 GPH (30.28 LPH) chilled water. Made of stainless steel, features include vandal-resistant bubbler heads, waste strainers and bottom plates. Grille slots are designed to eliminate sharp edges and are backed with a foam filter to protect the fan motor and high displacement compressor from debris.

Triple sensor-operated Model: H1119.8HO2-1920HO
Triple push button operated Model: H1119.8-1920

WALL MOUNTED OUTDOOR

1047 WALL-MOUNTED, CONCRETE FOUNTAIN

Wall-mounted design with child ADA capabilities. Heavy-duty, steel-reinforced construction with pre-cast, air-entrained concrete to ensure 5000+ PSI compressive strength. Hood extension protects the bubbler head with a partial enclosure for a greater protected drinking point. Exposed aggregate finish.



1109FRB BARRIER-FREE, FREEZE- RESISTANT, FOUNTAIN

Barrier-free, vandal-resistant, 18-gauge stainless steel drinking fountain includes a fully engineered pneumatic operated freeze-resistant valve assembly for continual use during winter months. Wall mounted design allows the unit to be placed securely in multiple locations without taking up excess space.

1119FRP BARRIER-FREE, FREEZE- RESISTANT, FOUNTAIN AND BOTTLE FILLER

Barrier-free, vandal-resistant, 18-gauge stainless steel drinking fountain and bottle filler incorporates a fully engineered pneumatic operated freeze-resistant valve assembly. Wall mounted design allows the unit to be placed securely in multiple locations without taking up excess space.



FEATURES & BENEFITS

- 100% lead-free waterways
- Polished, chrome-plated brass bubbler, push button and waster strainer
- Barrier-Free
- Front access stream adjustment, cartridge and strainer
- Vandal-resistant components and bottom plates
- Integral waste trap
- 100% U.S.A. factory pressure tested to meet the highest quality standards



**1025
BARRIER-FREE, HEAVY-DUTY
FOUNTAIN**

Barrier-free, heavy-duty 11-gauge fabricated galvanized steel with green powder-coated finish. Top-down drain access allows for cleaning without taking unit apart. Welded heavy-duty bubbler guard protects the drinking point from misuse. **AVAILABLE IN CUSTOM COLORS**



**1501
BARRIER-FREE, HI-LO,
ENAMELED IRON DUAL
FOUNTAIN**

Barrier-free, hi-lo, wall-mounted design with white enameled iron construction. Soft rounded corners prevent mishaps and other accidents that may occur once installed. Matching back panel provides a better base for a sturdier fountain.



**3690 Config WM
BARRIER-FREE, HEAVY-DUTY
BOTTLE FILLER**

Barrier-free, heavy-duty outdoor, ADA accessible outdoor wall mounted bottle filler uses a patented push-button stainless steel valve assembly allowing for front access stream adjustment as well as cartridge and strainer access.

**1431
ENAMELED IRON, TWO-BUBBLER FOUNTAIN**

Two-bubbler, enameled iron, barrier-free fountain provides for bullet-proof durability. Bubbler heads locked to main bowl prevent against vandals and provide efficient water flow for twice the users as single-bubbler fountains.



**1409
CAST ALUMINUM, MULTI-BUBBLER FOUNTAIN**

Multi-bubbler, barrier-free, white powder-coated cast aluminum construction. Gloss finish resists stains keeping the fountain protected. Three bubbler heads locked to main bowl prevent against vandals and provide efficient water flow in high traffic areas.



PEDESTAL OUTDOOR

3602 with 3670 dog bowl ADA OUTDOOR STAINLESS STEEL DUAL FOUNTAIN WITH DOG BOWL

Heavy-duty outdoor, ADA pedestal dual drinking fountains and dog bowl with matte silver powder-coated finish, and the option of adding/changing a drinking fountain, bottle filler, dog bowl and/or hose bib at any time. **AVAILABLE IN CUSTOM COLORS**



3612 ADA OUTDOOR STAINLESS STEEL BOTTLE FILLER AND DUAL FOUNTAIN

Heavy-duty outdoor, ADA pedestal bottle filler and dual drinking fountains with matte silver powder-coated finish, and the option of adding/changing a drinking fountain, bottle filler, dog bowl and/or hose bib at any time. Filtered model available 3612F. **AVAILABLE IN CUSTOM COLORS**



FEATURES & BENEFITS

- 100% lead-free waterways
- Barrier-Free
- Front access stream adjustment, cartridge and strainer
- Vandal-resistant components
- Chrome-plated brass bubbler, push button and waste strainer
- Aesthetically pleasing and protective powder-coated surfaces



**3300
HEAVY-DUTY, HI-LO FOUNTAIN**

Hi-lo, barrier-free design. Ready for any environment with heavy-duty, 11-gauge construction, bubbler guards and recessed push buttons. Freeze-resistant model, 3300FR. Bib faucet option available. **AVAILABLE IN CUSTOM COLORS**



**3511
HEAVY-DUTY, HI-LO FOUNTAIN**

Antique style pedestal made of heavy-duty, cast aluminum with powder-coated finish makes for one of the most stylish fountains that Haws produces. Standard color is black. Freeze-resistant model, 3511FR. Bib faucet option available.



**3610
ADA OUTDOOR STAINLESS STEEL BOTTLE FILLER**

Heavy-duty outdoor, ADA pedestal bottle filler with matte silver powder-coated finish, and the option of adding/ changing a drinking fountain, bottle filler, dog bowl and/or hose bib at any time. Filtered model available 3610F. **AVAILABLE IN CUSTOM COLORS**



**3380
GALVANIZED STEEL FOUNTAIN**

Heavy-duty, 11-gauge, fabricated galvanized steel with powder-coated finish provides exceptional corrosion resistance in one of our toughest made fountains. Standard color is green. Freeze-resistant model, 3380FR. **AVAILABLE IN CUSTOM COLORS**

**3202
ANGLED, TROUGH-STYLE FOUNTAIN**

Angled, barrier-free, trough-style design allows the pedestal to be placed securely in multiple locations where a gravel fill is present or can be installed. Gravel fill and trough design completely eliminate the need for traditional drains that can be clogged with sand and other contaminants. Bib faucet option available. Standard color is green. **AVAILABLE IN CUSTOM COLORS**



CUSTOM COLOR SELECTIONS



BRONZE MIST GREEN YELLOW RED BLUE SILVER BLACK WHITE BROWN ORANGE



CONCRETE PEDESTAL OUTDOOR



3150 ADJUSTABLE ARM, CONCRETE FOUNTAIN

Adjustable design allows the arm to be mounted at adult or child height as required by ADA. Hood extension protects the bubbler head with a partial enclosure for a greater protected drinking point.



FEATURES & BENEFITS

- Heavy-duty, steel-reinforced construction with precast, air-entrained concrete to ensure 5000+ PSI compressive strength, exposed aggregate finish
- Front access stream adjustment, cartridge and strainer
- Vandal-resistant components including recessed push buttons
- Polished, chrome-plated brass bubbler, push button and waste strainer
- Oversize access panels for ease of maintenance
- Attractive, high-polished stainless steel basins
- Top-down access to the drain allows the fountain to be cleaned without taking the unit apart
- Freeze-resistant options



3121
CONCRETE PEDESTAL FOUNTAIN

Square concrete design with exposed aggregate finish. Hood extension protects the bubbler head for a greater protected drinking point.



3177
ADA CONCRETE PEDESTAL FOUNTAIN

Angled, barrier-free with hood extension to protect bubbler head. ADA, wire-reinforced concrete pedestal drinking fountain with exposed aggregate finish and 100% lead-free waterways.

6620
SQUARE CONCRETE STEP

Matching square concrete step for square concrete pedestals. Steel-reinforced, pre-cast construction with air-entrained concrete to ensure 5000+ PSI compressive strength with exposed aggregate finish. 10" (25.4 cm) high for surface mounting.



6518FR
FREEZE-RESISTANT VALVE SYSTEM

Fully-engineered, pneumatic-operated, freeze-resistant valve system for all pedestal fountains. System is installed below the frost line.



EASY TO ORDER

- Go to www.hawesco.com
- Choose the model
- Select one of the four concrete finishes
- Select the concrete color

To view all concrete color options, go to www.hawesco.com

Four Concrete Finishes



LIGHT SANDBLAST MEDIUM SANDBLAST HEAVY SANDBLAST EXPOSED AGGREGATE

Sample of Concrete Colors



DESERT SAND C-11 WHITE 01 CORAL RED C-22 MESA BEIGE C-12 DARK GRAY C-34 SOMBERO BUFF C-25

SINK COUNTER-TOP MOUNTED



4110ADA **ENAMELED IRON DECK SINK**

Barrier-free capabilities when mounted at appropriate height. Recessed sink design with water tight fit and stainless steel mounting rim (not shown) helps to minimize excess splashing. Heavy-duty, cast iron basin with a glossy white, acid-resisting enamel finish. Pre-punched to accept two valves and/or faucets. Model shown with optional components.



SINK FEATURES & BENEFITS

- Barrier-Free
- Stainless steel or enameled iron construction
- Vandal-resistant components

FAUCET FEATURES & BENEFITS

- 100% lead-free waterways
- Polished, chrome-plated brass construction
- Vandal-resistant components



4230
BARRIER-FREE, COUNTER-MOUNTED SINK

Stainless satin finish resists stains and corrosion. Sunken sink design helps to minimize excess splashing and self-rimming allows for easy mounting, while the stainless steel construction provides durability and corrosion resistance. Water-tight fittings along with sound deadening undercarriage keep this unit mounted securely on any counter-top. Measurements: 31" x 19" x 5" (78.7 cm x 48.3 cm x 12.7 cm) deep. Model shown with optional components.



4010
STAINLESS STEEL DECK FOUNTAIN

Ideal for sink or counter-top locations. Stainless steel bubbler valve with adjustable stream regulation. Anti-squirt flow prevents surging water, keeping the drinking area contained and clean. Equipped with mounting bracket and waste strainer.

VALVE REPAIR KITS



VRK5872
VALVE REPAIR KIT

VRK5872 valve repair kit for model 5872. Includes push-button, adjusting spring, diaphragm ring slip, diaphragm assembly, valve stem, bottom spring, bottom plug "O" ring, and bottom plug.



VRK5874
VALVE REPAIR KIT

VRK5874 valve repair kit for model 5874. Includes wave washer, cartridge regulator and 60 mesh strainer.



VRK5874HF
VALVE REPAIR KIT

VRK5874HF valve repair kit for the models 1920 model series and the 3690. Includes wave washer, high flow cartridge regulator and 60 mesh strainer.

ACCESSORIES



5010.6427SS
A polished stainless steel push-button bubbler valve for countertop or sink mounting.



5017LF
All polished chrome-plated sink or counter-mounted drinking faucet with renewable control cartridge.



5051LF
Polished chrome-plated lever handle deck or sink-mounted bubbler valve.



5054LF
Self-closing lever handle, polished chrome-plated brass deck-mounted drinking faucet with automatic stream regulation.



5452LF
Self-closing lever handle, polished chrome-plated brass gooseneck faucet.



5510LF
Stay-open lever handle, polished chrome-plated brass gooseneck faucet.



5551
Push lever operated, self-closing, polished chrome-plated brass, deck-mounted, gooseneck cold water glass-filler faucet.



5874PB
Lead-free, stainless steel, push-activated, chrome-plated brass push button valve. Includes PBA7 recessed-style, push button assembly.



5874PBF
Flush-mount, lead-free, stainless steel, push-activated, chrome-plated brass, push button valve. Includes PBA6 flush-mount, push button assembly.



6250LF
Self-closing, plain end, lead-free, brass bib faucet with polished chrome-plated finish.



6252EHLF
Self-closing, plain end, bib faucet with rough brass finish and a special extended lever handle which is locked to valve.



6423
Replacement filter for models 2000S and 2000SMS bottle filling stations. (U.S. and Canada only)



6426
Filter, 12" x 2" (30.5 cm x 5 cm), in-line lead removal element that reduces lead from incoming water supply.



6455
Polished chrome-plated brass flat waste strainer.



6469
Drip tray used with the 1920 series bottle fillers for single or dual fountain.



6603
Satin finish stainless steel access panel. Includes frame and screws.



6611
Sand trap for installing adjacent to pedestal drinking fountains to help prevent debris and contaminants from clogging waste line. Use model 6635 for models 3500 and 3511.



6635
In-pedestal sand trap for models 3500, 3511 and 3600 series fountains.



6700
Universal mounting plate for most single bubbler wall-mounted fountains. Panel is 18" W x 7" H (45.7 x 17.8 cm).

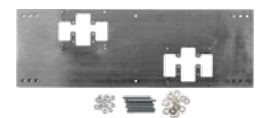

6700.4
Hi-lo universal mounting plate for most dual bubbler wall-mounted fountains. Panel is 36" W x 12" H (91 x 30.5 x).

ANTIMICROBIAL COPPER SAFE-TOUCH™ PUSH BUTTON New or Retrofit Options



PBA6C
Fits Valve Type
5874PBF

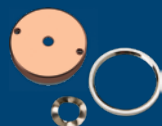

PBA7C
Fits Valve Type
5874PB



PBA8C
Fits Valve Type
Model 5010SS



ACCESSORIES



6700.4L
Mounting plate used with the 1920 series bottle fillers for dual fountain. Panel is 36" W x 7" H (91.4 x 17.8 cm).



6700R
Mounting plate used with the 1920 series bottle fillers for single or dual fountain retrofit installations. Panel is 14" W x 7" H (35.6 x 17.8 cm).



6715
In-wall mounting plate provides the maximum support and facilitates the installation of hi-lo, barrier-free, 1501 series fountains. Panel is 36" W x 14" H (91 x 35.6 cm).



6800
Universal in-wall mounting support for use with most fountains.



HCR8
Chiller provides for instantaneous cooling to meet a continuous demand for chilled water.



BP6
Back panel that increases location visibility. Model BP6 is 15" x 9" (38 cm x 22.9 cm) stainless steel with a satin finish. Used on model 1001.



BP15
Satin-finish stainless steel 15-inch back panel for Model 1920. Back panel is 15" x 17" (38 x 43.2 cm). BP15 and 1920 can be used with 1001 and 1107L models. Available in high-polished stainless steel, model BP15HPS.



BP32
Satin-finish stainless steel 32-inch back panel for Model 1920. Back panel is 32" x 9.5" (81 x 24 cm). BP32 is to be used with model 1920 and 1011, H1011.8, H1117.8 or 1117L. Available in high-polished stainless steel, model BP32HPS. Model BP32R has opening on upper left side, no high-polish available.



MTGFR.LG
In-wall mounting frame provides the maximum support and facilitates the installation of hi-lo, electric water coolers.

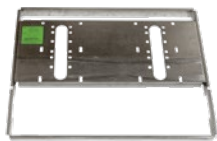

MTGFR.DF2
In-wall mounting frame provides maximum support and facilitates the installation of 1011MS and 1011HPSMS series fountains.



MTG.3501
Galvanized steel anchors.



SK1
Satin finish stainless steel cane touch skirt for high unit to comply with ADA protruding objects guidelines.



SK3
Satin finish stainless steel cane touch skirt for high unit to comply with ADA protruding objects guidelines when needed.

BOTTLE STAND KITS



BTL1001
Add-on, stainless-steel, bottle stand for the 1001/1011 series drinking fountains with the 1920 bottle filler installed.









BTL1107
Add-on, stainless-steel, bottle stand for the 1107/1117 series drinking fountains with the 1920 bottle filler installed.



BTL1311
Add-on, stainless-steel, bottle stand for the 1311/1501 series drinking fountains with the 1920 bottle filler installed.



FILTER MODEL OPTIONS

						
Filter Model	6422	6423	6425	6426	6428 & 6428-C	6477
Used In	Haws 2000 & 2000SM	Haws 2000S, 2000SMS, 2000SMSN, 2000SN, 2010, & 2010SM	Retrofit for Drinking Fountains & Bottle Fillers	Retrofit for Drinking Fountains & Bottle Fillers	All Filtered Models of 12XX-Series Electric Water Coolers & 36XX-Series Drinking Fountains	Retrofit for 36XX-Series Drinking Fountains
Connection to Head	Quarter Turn Connection	Threaded Connection	N/A	N/A	Quarter Turn Connection	Quarter Turn Connection
Plumbing Ports	3/8" Female Quick Connect (on Head)	1/4" Female Quick Connect (on Head)	3/8" Female NPT (on Filter)	1/4" Female NPT (on Filter)	3/8" Female Quick Connect (on Head)	3/8" Female Quick Connect (on Head)
Gallon Rating	2,500 Gallons	2,500 Gallons	1,000 Gallons	1,250 Gallons	3,000 Gallons	3,000 Gallons
Maximum Service Flow Rate	0.75 GPM	0.50 GPM	0.50 GPM	0.50 GPM	1.67 GPM	1.67 GPM
Filter Media	20 Micron Granular Activated Carbon	1 Micron Carbon Block	5 Micron Granular Activated Carbon	1 Micron Carbon Block	1 Micron Carbon Block	1 Micron Carbon Block
Removes/Reduces	<ul style="list-style-type: none"> •Chlorine Taste & Odor 	<ul style="list-style-type: none"> •Chlorine Taste & Odor •Lead •Cysts •VOC 	<ul style="list-style-type: none"> •Chlorine Taste & Odor •Sediment 	<ul style="list-style-type: none"> •Chlorine Taste & Odor •Lead •Cysts •VOC 	<ul style="list-style-type: none"> •Chlorine Taste & Odor •Lead •Cysts •VOC 	<ul style="list-style-type: none"> •Chlorine Taste & Odor •Lead •Cysts •VOC
Certifications	NSF/ANSI 42	NSF/ANSI 42 & 53	NSF/ANSI 42	NSF/ANSI 42 & 53	NSF/ANSI 42 & 53	NSF/ANSI 42 & 53
Advanced Features	Convenient Quick Change Feature	Electronic Total Flow Tracking	Retrofit Options	In-line Filter	RFID Filter Detection (12XX Units Only)	Kit Includes 6428 Filter & 0110000786 Head, Plus Associated Mounting & Plumbing

SCHOOL PRODUCTS

3612
OUTDOOR BOTTLE
FILLER & DRINKING
FOUNTAIN



7620
AXION® EYEPOD®



1409
WALL-MOUNTED
DRINKING FOUNTAIN



1212SF
HI-LO FILTERED
ELECTRIC WATER
COOLER & BOTTLE
FILLER



LEAD-FREE PRODUCTS SINCE 1990

Reduction of Lead in Drinking Water Act, an amendment to the Safe Drinking Water Act, establishes a maximum lead content of wetted surfaces of plumbing products to a weighted average of 0.25%. With an effective date of January 4, 2014, this law necessitates all potable plumbing products sold and installed meet the new lead reduction requirement.

All Haws® drinking fountain products are lead-free, as well as several AXION® Emergency Tempering Valves. These Haws products have NSF/ANSI/CAN 61: Q ≤ 1 and NSF/ANSI/CAN 372 certifications, obtained through the internationally recognized CSA Testing Laboratory, and are AB1953 compliant.



CERTIFICATIONS

AB1953

AB1953 is encompassed in the California Assembly Bill 1953, enacted in September of 2006, which calls for a reduction in lead content in all plumbing equipment including pipes, fittings, and fixtures to a level less than 0.25%. This law went into effect on the first day of January 2010 and all the aforementioned products sold and installed on and after that date must meet this AB1953 lead reduction requirement. In 1990, Haws® was already manufacturing products that fall within the lead reduction requirement that is now in effect.

All Haws drinking fountain products are lead-free, AB1953 compliant, and have NSF/ANSI 61-section 8 or section 9 and NSF/ANSI 372 certifications, obtained through the internationally recognized CSA Testing Laboratory.

CERTIFICATIONS

The CSA and UL certification marks signify that the product meets applicable U.S. and Canadian standards, including those from CSA, ANSI, ASME, ASSE, ASTM, IAPMO, NSF, and UL.

Below is a list of certifications that Haws drinking fountain models and optional accessories have been tested and certified to use. Certifications for each model can be found in the model descriptions at www.hawsc.com.

CSA: Canadian Standard Association International



FCC/IC: Electronic Product
FCC (U.S.), IC (Canada)

FCC/IC

UL: Underwriters
Laboratories



Wheel Chair Accessible products

NSF/ANSI/CAN 61-2020 CERTIFIED

Haws is pleased to announce that our hydration products meet the new Lead-Free Plumbing Fixtures requirements ahead of the National and State of California standard deadlines. Haws is ahead of the deadlines and products are already in full compliance with the new lead-free requirements. We have more than 180 hydration models and component products now certified to the new NSF/ANSI/CAN 61-2020 requirements.



MASTERSPEC®, REVIT, CAD

Masterspec® files now available for Haws products, as well as revit and cad files from caddetails and bim object.





DON'T SEE EXACTLY WHAT YOU'RE LOOKING FOR?

Our team can help create a personalized product solution to fit your needs.

Below are some commonly ordered custom designs:

- Custom colors
- Modified product dimensions
- Custom logos

Call us at 888.640.4297, or email info@hawsco.com



TECHNICAL DOWNLOADS

US/Canada

Haws HQ
www.hawsco.com
+1.888.640.4297

Latin America

Haws LATAM
www.hawsavlis.com.br
+55.11.4813.9977

Europe/Middle East/Africa

Haws EMEA
www.haws.ch
+41 (0) 34.420.6000

Asia Pacific

Haws APAC
www.haws.sg
+65.6367.0359

Haws India
www.hawsco.in
+91.124.494.2050



1455 Kleppe Lane
Sparks, NV 89431

www.hawsco.com
Email: info@hawsco.com

+1.888.640.4297
+1.775.359.4712
Fax: +1.775.359.7424